

Dymax BlueWave® 75 Rev. 2.0 User Guide

UV Light-Curing Spot Lamp

- Instructions for Safe Use
- Setup and Operation
- Maintenance
- Ordering Spare Parts and Accessories



About Dymax

UV/Visible light-curable adhesives. Systems for light curing, fluid dispensing, and fluid packaging.

Dymax manufactures industrial adhesives, light-curable adhesives, epoxy resins, cyanoacrylates, and activator-cured adhesives. We also manufacture a complete line of manual fluid dispensing systems, automatic fluid dispensing systems, and light-curing systems. Light-curing systems include LED light sources, spot, flood, and conveyor systems designed for compatibility and high performance with Dymax adhesives.

Dymax adhesives and light-curing systems optimize the speed of automated assembly, allow for 100% in-line inspection, and increase throughput. System designs enable stand-alone configuration or integration into your existing assembly line.

Please note that most dispensing and curing system applications are unique. Dymax does not warrant the fitness of the product for the intended application. Any warranty applicable to the product, its application and use is strictly limited to that contained in the Dymax standard Conditions of Sale. Dymax recommends that any intended application be evaluated and tested by the user to insure that desired performance criteria are satisfied. Dymax is willing to assist users in their performance testing and evaluation by offering equipment trial rental and leasing programs to assist in such testing and evaluations. Data sheets are available for valve controllers or pressure pots upon request.

Contents

Introduction	4
Where to Get Help	4
Safety	4
UV Light-Curing System Safety Considerations	6
Product Overview	8
Description of the <i>BlueWave 75</i>	8
Assembly and Setup	9
Unpacking and Inspecting Your Shipment.....	9
Parts Included with the <i>BlueWave 75</i>	9
Installation and System Interconnect	10
Settings and Adjustments	11
Intensity Adjustment	11
Intensity Validation	12
Intensity Control.....	12
Setting the Cycle Duration.....	12
Lamp Dual-Hour Meter.....	13
System Operation	14
Maintenance	15
Lightguide Maintenance	16
Fuse Replacement	15
Fan Filter Maintenance.....	16
Bulb Replacement	16
Troubleshooting	19
Frequently Asked Questions	20
Spare Parts and Accessories	22
Spare/Replacement Parts.....	22
Options/Accessories	23
Specifications	24
Specifications.....	24
Definition of Terms	25
Warranty	26
Replacement Bulb Warranty	26
Index	27

Introduction

The enclosed *BlueWave 75* UV Light-Curing Spot Lamp System was developed and manufactured by the Dymax team, driven by a desire to best serve your needs. Before shipping, your *BlueWave 75* was thoroughly checked and tested for trouble-free performance.

The proper setup and operation of this system will maximize safety and user-friendly performance, providing optimum yield of your technological process.

Therefore, we encourage you to read, understand, and follow all safety and operating instructions and recommendations compiled in this and other related manuals prior to setting up and operating this new spot-lamp system or its individual components.

If you encounter a problem, have any questions, or would like to pass on your suggestions or recommendations, please contact our Application Engineering or Customer Service Departments. Trained Dymax professionals are standing by to serve you.

Par conséquent, nous vous encouragez à lire, comprendre, et suivre toute sécurité et instructions d'opération et conseils rédigés dans cette et autres manuels établis avant de mettre en place et de faire fonctionner ce nouveau système de lampe de tâche ou ces composants individuels.

Si vous rencontrez un problème, avez n'importe de questions, ou si vous voudrez de nous aider avec vos suggestions ou conseils, s'il vous plaît contactez notre département technique ou service client. Dymax formé professionnels attendent à vous servir.

Where to Get Help

Additional resources are available to ensure a trouble-free experience with our products:

- Detailed product information on www.dymax.com.
- Customer Support and Applications Engineering teams are available by phone and email in Germany, Monday through Friday, from 8:00 a.m. to 5:00 p.m. Central European Time. You can also email Dymax Europe GmbH at info_de@dymax.com. Please see the back cover for worldwide contact information.
- Dymax adhesive Product Data Sheets (PDS) on our website
- Material Safety Data Sheets (MSDS) provided with shipments of Dymax adhesives

Safety



CAUTION! Always wear proper eye protection when working with this unit, which emits high-intensity ultraviolet and visible energy! Note: The rear of the unit also emits stray UV & Visible energy.



WARNING! Always observe safety requirements!



CAUTION! Risk of electrical shock if cover is removed!



CAUTION! Cover is warm to the touch when unit is in operation!

Equipment is designed to be used properly setup, with components correctly connected and operated in accordance with relevant instructions. The system's design was developed to maximize operator safety and minimize exposure to UV.

Safety Recommendations

- Use the provided safety eyewear or an approved face shield for eye/face protection.
- Long-sleeved shirts or a lab coat are recommended to protect arms and the use of UV opaque gloves will protect the hands.

NOTE: The BlueWave 75 emits UVA and visible light. Never look directly into the lightguide entrance fitting or end of lightguide while the unit is on.

Sécurité



PRÉ-CAUTION! *Toujours faire de l'usage des lunettes de protection ou protéger de visage marche près du devant d'élément!*



AVERTISSEMENT! *Remmarquez toujours besoin de sécurité!*



PRÉ-CAUTION! *Risque de décharge électrique quand le couvert est enlever!*



PRÉ-CAUTION! *Le couvert est chaud a le touche quand l'élément est en opération!*

L'équipement être conçu pour être utilisé correctement constituer, avec composants brancher correctement, et marché en conformément avec instructions important. Le plan états développer pour rendre au maxime opérateur sécurité et minimiser exposition à ultraviolette.

Recommander de Sécurité

- Emploi lunettes, ou un protéger de visage pour protection de ultraviolet pour protéger vous yeux.
- Chemises à manche long, ou manteau de labo, sont recommander pour protéger les bras, et utilisation de ultraviolette gants opaque vais protéger les mains.

REMARQUER: Avec le filtre intérieur installé, l'onde bleu émettre lumière. Ne jamais regardez directement à la source de lumière pendant que l'élément est en opération.

Sicherheitshinweise



ACHTUNG! *Tragen Sie immer eine Sicherheitsbrille oder einen Gesichtsschutz, wenn Sie nahe an der UV Lichtquelle arbeiten. Die Rückseite des Gerätes emittiert gestreutes UV Licht!*



WARNHINWEIS! *Bitte beachten Sie immer die Sicherheitshinweise!*



ACHTUNG! *Gefahr eines Stromschlages bei geöffnetem Gehäuse!*



ACHTUNG! *Gehäuse erwärmt sich während des Betriebs: Vorsicht bei Berührung!*

Dieses Gerät wurde so entwickelt, dass es nur vollständig, alle Komponenten korrekt miteinander verbunden, in Übereinstimmung mit relevanten Instruktionen betrieben wird. Bei der Entwicklung wurde weiterhin großen Wert auf die Benutzersicherheit und minimale UV Belastung gelegt.

Sicherheitshinweise

- Tragen Sie immer die mitgelieferten Sicherheitsbrille oder speziellen Gesichtsschutz, der Ihre Augen vor UV Licht schützt.
- Wir empfehlen Langarm - Hemden oder einen Laborkittel zu tragen, um die Arme zu schützen. Für die Hände empfehlen wir UV- geblockte Handschuhe.

BITTE BEACHTEN SIE: Durch den installierten inneren Filter strahlt die BlueWave 75 und sichtbares Licht aus. Schauen Sie deshalb niemals direkt in die Lichtquelle, wenn das Gerät angeschaltet ist.

UV Light-Curing System Safety Considerations

Dymax light-curing technology has been used successfully for over 30 years. The fast cure, one-component nature of our curing technology has made it the process of choice for many manufacturers requiring a “cure on demand” assembly process. There are four common questions/concerns related to light-curing systems: UV exposure, high-temperature surfaces, ozone, and bright, visible light.

UV Exposure

Standard Dymax UV light-curing systems have been designed to primarily emit UVA light (Figure 1). UVA light is generally considered the safest of the three UV ranges: UVA, UVB, and UVC. Although OSHA does not currently regulate ultraviolet-light exposure in the workplace, the American Conference of Governmental Industrial Hygienists (ACGIH) does recommend Threshold Limit Values (TLV’s) for ultraviolet light. The strictest interpretation of the TLV (over the UVA range) for workers’ eyes and skin is 1 mW/cm² (intensity), continuous exposure. Unless workers are placing bare hands into the curing area, it is unusual to exceed these limits. To put 1 mW/cm² limit into perspective, cloudless summer days in Connecticut regularly exceed 3 mW/cm² of UVA light and which includes the more dangerous UVB light, primarily responsible for sun tans, sun burns, and skin cancer.

The human eye cannot detect “pure” UV light, only visible light. A radiometer should be used to measure stray UV light to confirm the safety of a UV-curing process. A workstation that exposes an operator to more than 1 mW/cm² of UVA continuously should be redesigned.

Figure 1. Spectrum of Light

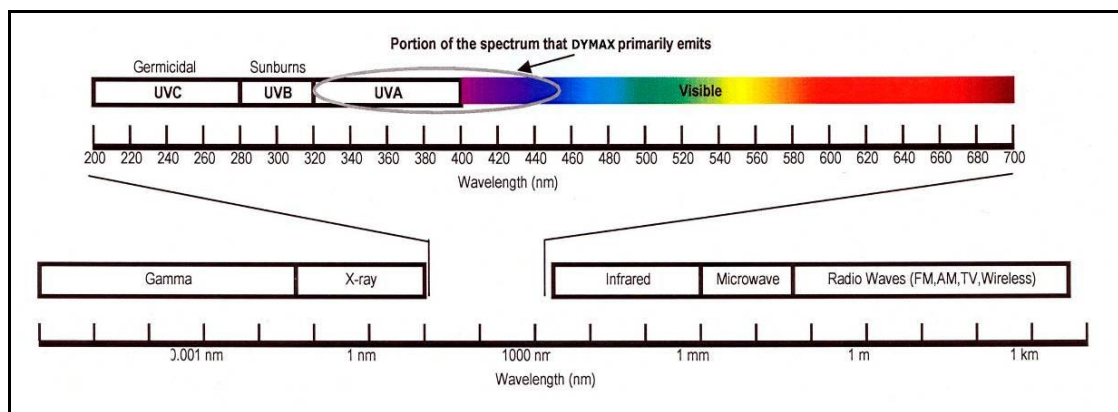

Light-curing technology can be a regulatory compliant, “worker-friendly” manufacturing process when the proper safety equipment and operator training is utilized. There are two ways to protect operators from UV exposure: shield the operator and/or shield the source.

Shield the Operator

UV-Blocking Eye Protection – UV-blocking eye protection is recommended when operating UV-curing systems. Both clear and tinted UV-blocking eye protection is available from Dymax.

UV-Blocking Skin Protection – Where the potential exists for UV exposure upon skin, opaque, UV-blocking clothing, gloves, and full-face shields are recommended.

Shield the Source of UV Light

Any substrate that blocks UV light can be used as a shield to protect workers from stray UV light. The following materials can be used to create simple shielding structures:

Sheet Metal – Aluminum, steel, stainless steel, etc. Sheet metal should be coated black or black anodized to minimize reflection of UV and visible light toward operators.

Rigid Plastic Film – Transparent or translucent, UV-blocking plastics (typically polycarbonate or acrylic) are commonly used to create shielding where some level of transparency is also desired.

Flexible Film – Translucent UV-blocking, flexible urethane films can be used to quickly create workstation shielding. This UV-blocking, flexible urethane film is available from Dymax.

High-Temperature Surfaces

Surfaces exposed to high-intensity curing lights will rise in temperature. The intensity, distance, exposure time, cooling fans, and the type/color of the surface can all affect the actual rise in surface temperature. In some cases, exposed surfaces can reach temperatures capable of producing a burn or causing damage to a substrate. In these cases, care must be taken to ensure either a more moderate surface temperature or appropriate protection/training for operators.

Ozone

Standard Dymax bulbs (UVA type) generate an insignificant amount of UVC and therefore essentially no ozone. Some UV light-curing systems, like those used to cure UV inks, emit primarily “shortwave” (UVB and UVC) energy. Upon exposure to UVC energy (specifically <240 nm), oxygen molecules (O₂) split into oxygen atoms (O) and recombine with O₂ to create ozone O₃. The current, long-term ozone concentration limit recommended by ACGIH, NIOSH, and OSHA is 0.1 ppm (0.2mg/m³).

Bright, Visible Light

The bright, visible light energy emitted by curing systems can cause eyestrain if proper eye protection or shielding is not used. Tinted eye protection and/or opaque/tinted shielding can be utilized to address this concern.

Summary

UV-light sources can be more “worker friendly” than many commonly accepted industrial processes, provided the potential concerns are addressed. Both the lower working temperature and lack of spurious frequency transmission that this system produces make it even more user friendly. Contact your Dymax representative for information regarding the proper use of Dymax light-curing systems.

Product Overview

Description of the *BlueWave 75*

The *BlueWave 75* is a high-intensity, UV light-curing spot lamp used for the curing of adhesives, coatings, and potting materials. It emits UV light from a lightguide which can be hand-held for complete mobility, fixtured into position for repetitive operations, or integrated into automated equipment.

The unit consists of an anodized aluminum housing, containing an electronic power supply, circuit protection, a bulb/reflector assembly, an internal light filter, a thermostatically-controlled cooling fan, a lightguide mount, bulb and unit status indicator lights, a combination resettable and non-resettable hour-meter, and a shutter system. A thermal shutdown sensor is provided for internal temperature control of the unit. A cover-closed switch and lightguide-sensing switch add to the safety of the unit. Fan filters should be changed or cleaned frequently to prevent blockage and reduced ventilation airflow. Electric shutters are supplied with timed and manual shutter operating modes. The lightguide is separate and plugs into the lightguide entrance fitting on the front panel (the forward facing lightguide mount).

An intensity control feature allows operators to adjust output intensity during process validation and production. Users can now manually adjust intensity to compensate for bulb degradation and to maintain an optimized output or allow it to emit direct line of sight energy to unprotected personnel.

CAUTION: *Once the lightguide is engaged there exists the possibility of light emitting if the unit is triggered. Never look directly into the lightguide.*

A cooling fan is provided to keep the bulb housing and internal components of the power supply at the optimum operating temperature. The fan or exhaust opening must not have any restriction in their airflow path. The UV source is a 75-Watt short-arc bulb mounted in a reflector and pre-focused to provide optimum light output. The unit is rated for continuous operation.

The blue indicator light (located above the lightguide mount) lights when the bulb is operating. The power supply operates on line voltages between 100 and 240 VAC and frequency between 50 and 60 Hz.

If the bulb extinguishes due to a momentary power failure the unit must be turned off and allowed to cool 20 minutes before attempting to re-ignite the bulb. Arc-type bulbs are designed to (and prefer) to be run continuous. Repeated on/off cycling decreases bulb life and accelerates intensity degradation. It is good practice to leave the unit running for a full 8-10 hour shift and only turn the unit off if it will be off for more than a few hours or overnight.

Figure 2. *BlueWave 75* Front Face Plate

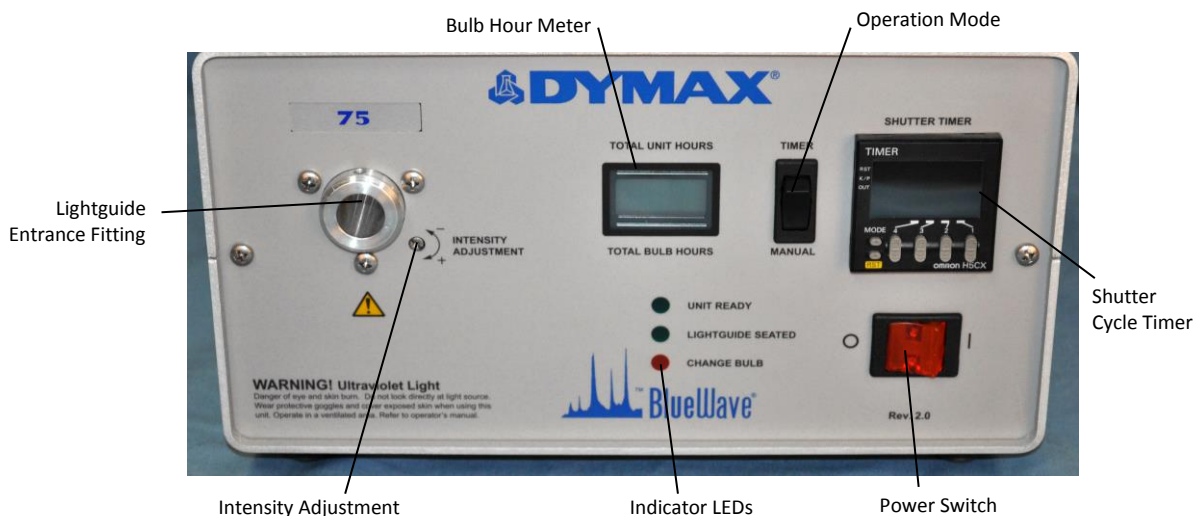

Assembly and Setup

Unpacking and Inspecting Your Shipment

Depending upon your order, your *BlueWave 75* will arrive in one or two boxes. Inspect the boxes for damage and notify the shipper of box damage immediately.

Open each box and check for equipment damage. If parts are damaged, notify the shipper and submit a claim for the damaged parts. Contact Dymax so that new parts can be shipped to you immediately.

Check that the parts included in your order match those listed below. If parts are missing, contact your local Dymax representative or Dymax Customer Support to resolve the problem.

Parts Included with the *BlueWave 75*

- *BlueWave 75* Spot Curing Lamp (1)
- *BlueWave 75* Spot-Curing System User Guide (2)
- UV Protection Goggles (3)
- Power Cord; Style Dependent on Model Ordered (4)
 - 40078 – 115V Standard North American Power Cord
 - 40077 – Type G Power Cord
 - 40183 – No Power Cord (Note: For European customers, the appropriate power cord will be added)
- Tools - Hex Wrench (5) & Screw Driver (6)
- Footswitch (7)

Figure 3. *BlueWave 75* Unpacking Diagram

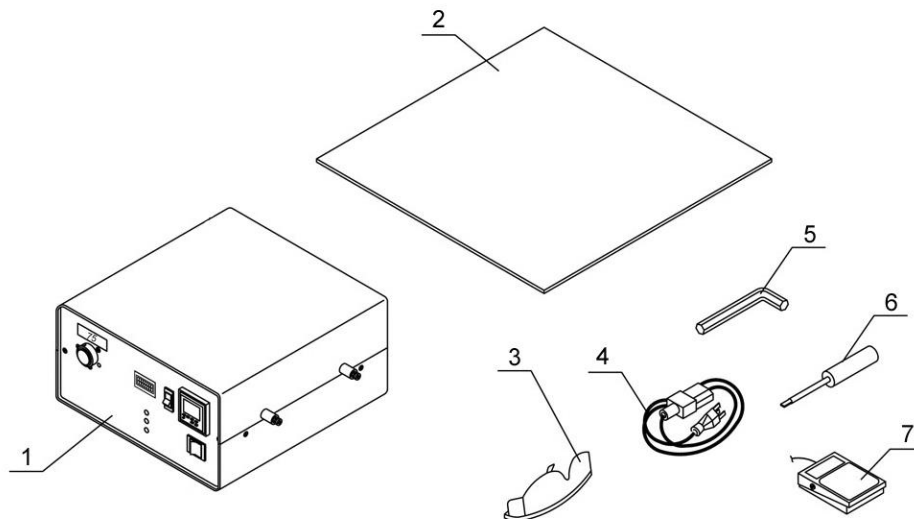

NOTE: Units are shipped with the Bulb/Reflector installed

Installation & System Interconnect

1. Connect the Power Cord to the back of unit and plug the other end into a grounded wall outlet.
2. Connect the Footswitch to the connection in the back of the unit. A Ground Stud is provided on the back of the unit if additional grounding is desired.

Figure 4. Rear Cable Connections

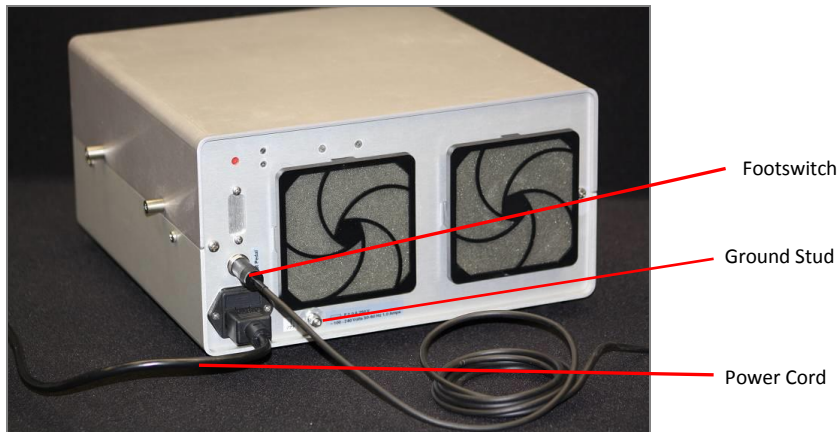

3. Remove the protective end caps from the Lightguide (purchased separately). Visually inspect the two ends to verify that no foreign material is present. If required, the ends of the Liquid-Filled Lightguide can be cleaned with isopropyl alcohol to remove oils and debris. Attach the Lightguide by removing the shipping cap covering the Lightguide Mount (Figure 5) and inserting the Lightguide. Lightly tighten the setscrew on the Lightguide Mount to secure the Lightguide (Figure 6).

NOTE: Do not over tighten the setscrew as permanent and non-warranty damage will result.

Figure 5. Shipping Cap in Lightguide Mount



Figure 6. Lightguide Connection



4. Turn the Power Switch to the on position.
5. Allow the bulb to warm up (about 5 minutes). The unit is warmed-up when the blue Unit Ready LED illuminates and two beeps sound. The Shutter will be inoperable until the warm-up is complete and a Lightguide is installed.

Note: If the unit is coming on from an extreme cold condition (<0°C), the system fan will turn on to initiate a warming cycle and the Unit Ready LED will pulse as ambient air (>2°C) is being circulated

through the unit. Once the internal temp is $>2^{\circ}\text{C}$, the bulb will ignite and the normal warm-up cycle will commence.

- Operate the Shutter by pressing the Footswitch. With the Shutter Selector Switch in the manual position, the Shutter operates directly from the Footswitch and will remain open as long as the switch is depressed. In the timed position, the open duration of the Shutter is determined by the setting on the electronic Shutter Timer. A momentary depression of the Footswitch will initiate the timed cycle and the Shutter will remain open for the duration of the cycle (the counter will count down the time until the Shutter closes).
- With the Shutter open, adjust the Intensity Adjustment Screw as required to achieve the desired output intensity. The output intensity can be measured using an ACCU-CAL™ 50 Radiometer or equivalent.

CAUTION: This unit uses an arc bulb, not a filament bulb. Once ignited, the unit must be left on for a minimum of 10 minutes to vaporize elements in the bulb. If the unit is not left on for the required time, re-ignition of the bulb may be difficult or unreliable.

Note: The bulb must cool before it can be re-ignited. Turn the unit off and allow 20 minutes for it to cool down. If the bulb fails to ignite, refer to the “Troubleshooting” section of this manual. Bulb life is reduced each time the unit is switched on. Avoid repeated cycles that shorten bulb life by leaving the unit on through breaks.

Settings and Adjustments

Intensity Adjustment

A Dymax ACCU-CAL™ 50 Radiometer can be used to set and monitor the unit's intensity output. If the BlueWave 75's output intensity needs adjustment, use the Intensity Adjustment Knob. This knob installs into the Intensity Adjustment Screw (Figure 7) using the M2 screw included with the unit. A small screwdriver (included) can also be used to adjust the intensity (Figure 8). If it is undesirable to allow the operator easy access to the intensity adjustment, it is recommended that the Intensity Adjustment Knob not be attached.

Figure 7. Intensity Adjustment Knob



Figure 8. Adjusting Intensity with a Screwdriver



Turning the Intensity Adjustment Knob fully clockwise will provide full intensity out the Lightguide. As the Intensity Adjustment Knob is turned counter-clockwise the intensity will slowly be reduced.

Intensity Validation

Prior to production, Dymax advises customers to conduct testing to determine the time and intensity required to fully cure their resin in their specific application. Typically, users validate by one of the following methods:

- **Set Exposure Time, Determine Intensity:** Users can specify a cure time and through empirical testing, determine the intensity required to achieve full cure. As with any manufacturing process, it is advisable to incorporate a safety factor.
- **Set Intensity, Determine Exposure Time:** Users can specify intensity and through empirical testing, determine the exposure time required to achieve full cure. As with any manufacturing process, it is advisable to incorporate a safety factor.

Intensity Control

Process validation confirms a minimum acceptable intensity. Users can then choose to operate at full intensity (using the excess intensity as an additional safety factor) or maintain a constant intensity through periodic manual adjustments.

BlueWave 75 bulbs will typically vary less than 1% over eight hours of normal use and so daily or weekly adjustments are adequate to maintain a tightly controlled process. A Change Bulb Indicator LED is provided to alert the operator to check bulb operation or to change the bulb if required.

Setting the Cycle Duration

The Shutter Timer located on the front panel of the *BlueWave 75* is factory set to the most common operating mode and recommended operation of the Shutter Timer with the *BlueWave 75*. Some modes available on this Shutter Timer may not operate correctly with the *BlueWave 75* unit and have been disabled.

The Shutter Timer has an LCD Display and Keypad. The LCD Display has a Reset Indicator, Key Protect Indicator, Output Indicator, Preset Value, Set Value, and Timing Operation Indicator. Below is a brief description of each display and location.

Figure 9. Shutter Timer



- **RST [Reset Indicator]** – This setting becomes active when the Shutter Timer is reset by pressing the “RST” Button (Reset Button) on the lower left face of Shutter Timer.
- **K/P [Key Protect]** – This setting is always lit as the function of the Shutter Timer is programmed at the factory and locked before shipment.
- **OUT [Output Indicator]** – This setting is displayed when the relay is switched on and is not displayed when the relay is switched to off.
- **RST [Reset] Button** – This button is located in the lower left corner of the Shutter Timer. Pressing this button will reset the Shutter Timer.
- **Timing Value** – This is a four-digit segmented display in the center of the Shutter Timer. It shows the current status of time.
- **Set Value** – This is a four-digit segmented display in lower right corner of the Shutter Timer. It shows the set length of time.

In addition to the indicators, the Shutter Timer contains six buttons with their functions described as follows:

- **MODE** –Disabled at the factory and locked before shipment.
- **Reset Indicator (RST)** – Used to cancel out of a timed cycle. If a cycle is initiated and counting down, pressing this button will close the Shutter and reset the counter to the current preset.
- **Digit Increment 1-4:** Pressing these buttons up or down will increment or decrement that digit by one. The timer digits are formatted MM:SS for a maximum Shutter time of 99 minutes and 0.99 seconds. Consult Dymax for information on changing the format of this Timer.

To set the Shutter’s open duration, press the appropriate up/down button until the corresponding digit increments in the set value. Pressing the key labeled 1 will increment the left most digit on the set value. Pressing the key labeled 2 will increment the second digit of the set value and similar for digits 3 and 4. The small grey buttons are rocker style so pressing the top half increments the digit up, while pressing the bottom half will increment down. The Timer will increment from 9 back to 0. The Timer comes programmed for a range of 00.01 seconds to 99.99 seconds. Contact Dymax for other time ranges and functions.

To operate the Timer, select the Timer Operation Mode on the front panel (large rocker switch left of the Shutter Timer). Program the correct time into the Timer and depress the Footswitch. The Shutter will open and the preset value will begin to count backward. When the Timer reaches 00.00, it will reset to the programmed value and the Shutter will close. The Timer can be stopped once started by pressing the Reset Button on the lower left face of the Timer. If power is removed from unit, the Timer will reset to the programmed value.

Lamp Dual-Hour Meter

The Lamp Dual-Hour Meter (Figure 10) provides the unit’s total hours of operation (top display), as well as the bulb usage (bottom display). The total unit hour display continues to count hours of operation on the unit and cannot be reset. The lower display reflects the number of hours on the bulb.

Bulb hours should only be reset when a new bulb is installed. Instructions for bulb replacement are found in this user guide and are also located on a label under the unit cover next to where the bulb is located.

When the Lamp Hour Meter reaches 2,000 hours, the bulb will turn off and the Hour Meter will alternate between "CHANGE BULB" and "2000.0". The unit will not operate until a new bulb is installed as described in the Maintenance Section of this user guide.

WARNING: Operating a BlueWave 75 Lamp beyond 2,000 hours will result in a non-passive failure of the lamp! Do not reset the Lamp Hour Meter without replacing the bulb.

Figure 10. Lamp Dual-Hour Meter

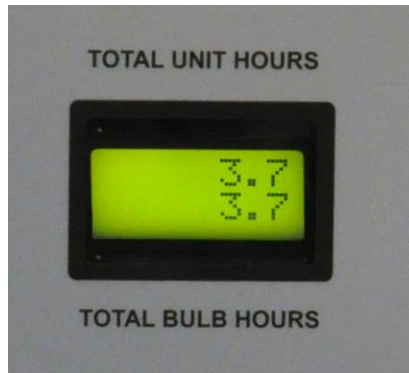

System Operation

1. The *BlueWave 75* will arrive almost fully assembled. Please refer to Installation and System Interconnect for installation of the Lightguide, Power Cord, and Footswitch. The system should be positioned in a dry location that does not obstruct airflow from the rear of the unit.

Note: Do not block the vents at the rear of the unit. Allow a minimum of 12" [150 mm] clearance from the back vents to the nearest obstructing surface.

2. Follow the procedures for connecting the Power Cord, Footswitch, Lightguide, and additional Grounding Wire (if necessary).
3. Follow the steps to set the desired intensity and shutter cycle duration.
4. The Lightguide can be hand held, fixed over the curing area using an optional Lightguide Mounting Stand (PN 39700), or fixtured using custom tooling. The UV and visible light emitted from a Lightguide diverges. As a result, the intensity decreases and the curing area increases with distance from the end of the Lightguide. Figure 11 shows this relationship for the 5-mm Liquid Lightguide. Values given are for general reference; actual intensities can be measured using a Radiometer.
5. Apply the proper Dymax product for the application, fixture if necessary, and cure using the *BlueWave 75*.

Note: For additional information on light-curing systems, refer to Dymax LIT010 – Guide to Selecting and Using Dymax Light-Curing Systems and LIT008 – Comprehensive Guide to Dymax Light-Curing Technology.

Figure 11. Curing Area/Intensity VS. Distance using a 5-mm Lightguide

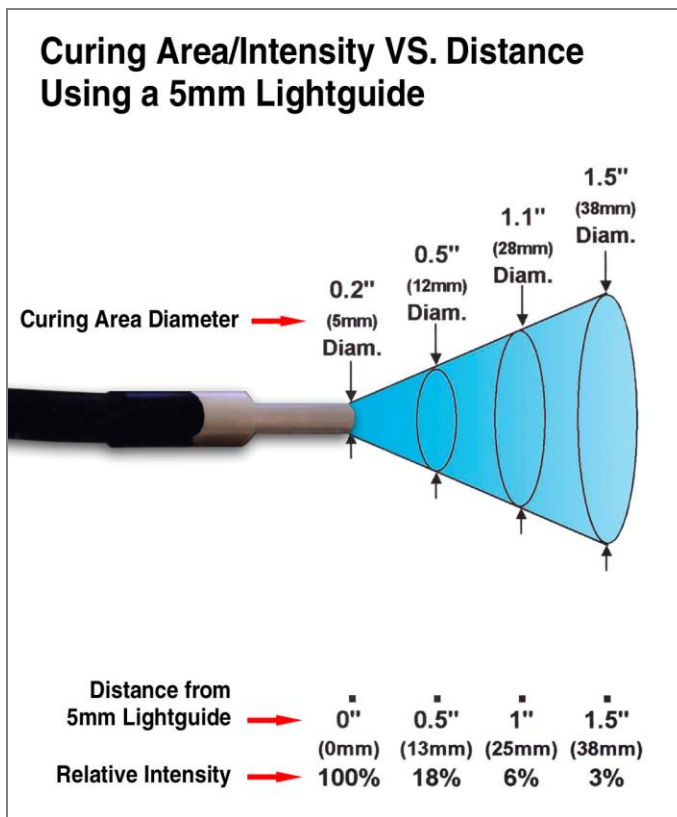

Maintenance

The *BlueWave 75* was designed to operate with minimum maintenance and following basic steps below will assure continued top performance.

Fuse Replacement

The unit has two Fuses that are installed in the Power Receptacle. To remove the Fuses, unplug the unit and remove the Fuse Holder with a small screwdriver (Figure 12). Remove the Fuses from the Fuse Holder and install new Fuses. Replace the Fuse Holder into the Power Receptacle (Figure 14).

Figure 12. Power Receptacle



Figure 13. Fuse Holder



Figure 14. 2.0 Amp Fuse (PN 41279)



Fan Filter Maintenance

The external Fan Filters should be inspected and cleaned periodically to prevent dust buildup from affecting airflow through the unit. Spare Fan Filters are provided with each unit and with replacement Bulbs. The Fan Filters are washable and may be reused. Remove the Fan Filter by removing the Snap-On Cover from the rear of each Grill.

Figure 15. Fan Filter Replacement



Lightguide Maintenance

Clean the Lightguide ends monthly or as required. The ends of the Lightguide should be kept clean to transmit as much energy as possible. Cured adhesive can be removed with a razor blade or isopropyl alcohol (IPA). Avoid tight radius bends of the Lightguide since this will reduce output and may cause permanent damage to the guide.

Bulb Replacement

1. Unplug the unit. Remove the top cover from the *BlueWave 75* by loosening the four cover fasteners (these are the four extended screws on the sides of the top cover).
2. Unplug the Bulb Connector and loosen the two knurled screws shown in Figure 16. Pivot the white Bulb Clamp up and out of the way to allow removal of the Bulb.

Figure 16. Bulb Replacement Step 1-2

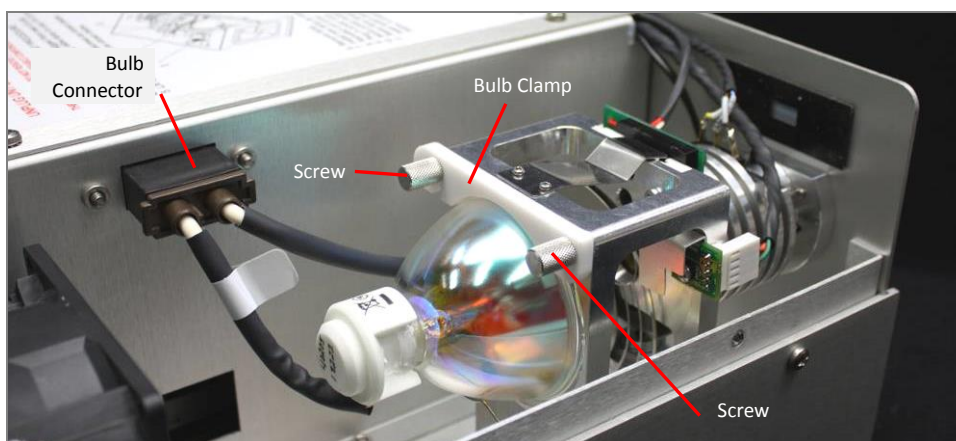

3. Gently tip the back end of the Bulb down to un-seat the top edge and remove the Bulb.

Figure 17. Bulb Replacement Step 3

4. Using powder free gloves, unpack the new Bulb (PN 40205). Take care not to bend the Flat Electrode in the center of the Bulb.
5. Orient the new Bulb so the Side Electrode Wire is positioned at the side of the housing that is open. Carefully seat the bottom edge (Figure 18). The lower Retaining Spring Wire will exert resistance that you will need to overcome as you seat the Bulb. With the lower edge seated, tip the top edge into the upper seat. The Bulb will remain in place if properly installed.

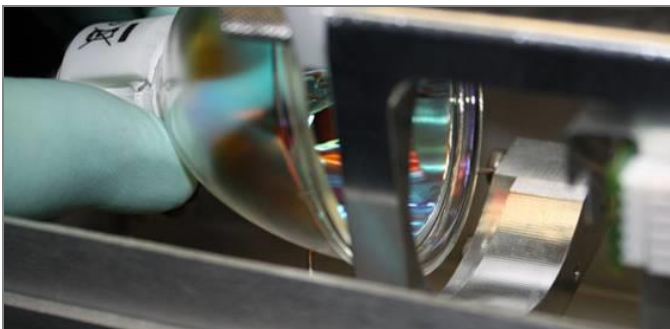
Figure 18. Bulb Replacement Step 5

6. Pivot the white Bulb Clamp in place and tighten the two knurled screws. Plug in the Bulb Connector (Figure 19).

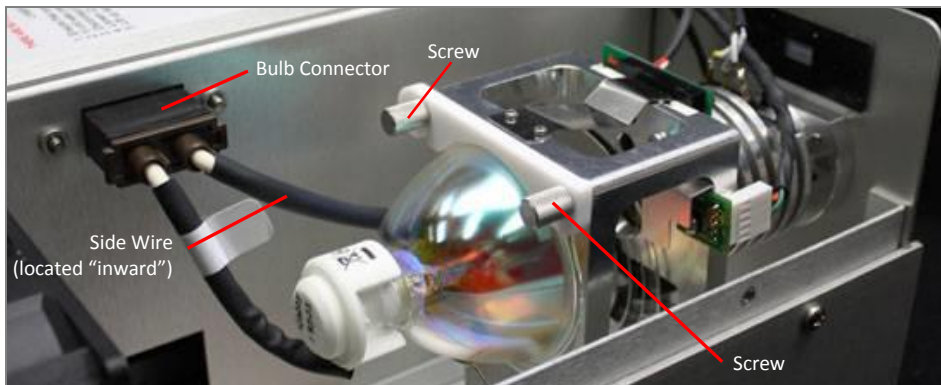
Figure 19. Bulb Replacement Step 6

7. Replace the unit's cover and tighten the four cover fasteners. Once the cover is secure, power up the unit and using a small screw driver press the Reset Button located on the back of the unit. This will

reset the Bulb Hour Meter but not extinguish the Change Bulb Indicator Light. Cycle the system power once to reset the Change Bulb Indicator Light.

Figure 20. Bulb Replacement Step 7



Note: Fan Filters (included with replacement bulbs) MUST also be replaced during a bulb change.

8. Once the new Bulb is installed and operational, it is recommended that the intensity is set again (see Settings and Adjustments Instructions).

Troubleshooting

WARNING! Only qualified maintenance personnel should attempt the following procedures.

AVERTISSEMENT! Seulement personnel d'entretien diplômé devrais essayer les procédures suivant.

Table 1. Troubleshooting Chart for BlueWave 75

Problem	Possible Cause	Testing	Corrective Action
Bulb will not ignite or Change Bulb Light is on	Improper connections	Visually inspect all input/output connections (i.e. Power Cord, Bulb).	Secure all connections.
	Bulb is beyond useful life of 2,000 hours	Replace with a new Bulb/Reflector Assembly. Reset Bulb Hour Meter and re-test unit.	Replace Bulb/Reflector Assembly if required. Typical Bulb life is 2,000 hours.
	Main line Fuse blown (nothing in unit operates)	Remove Fuse from Power Receptacle and check with an Ohmmeter.	Replace Fuse, if defective.
Low output intensity or System fails to cure adhesive in allotted time	Bulb beyond useful life	Use a Radiometer to measure output intensity (Dymax ACCUCAL™ 50 or equivalent).	Replace Bulb/Reflector Assembly if beyond useful life.
	Transmission loss in Lightguide too great	Compare Lightguide output against new Lightguide (or use the Dymax Lightguide Simulator) to determine transmission loss.	Inspect and clean guide ends, and eliminate tight bends. Replace Lightguide.
	Contaminants on Lightguide	Visually examine ends of Lightguide for contaminants.	Clean with isopropyl alcohol or equivalent. Heavy deposits on liquid Lightguides may be carefully removed using a razor blade. Replace the Lightguide if it cannot be cleaned.
	Bulb/Reflector Assembly not installed properly	Visually check to make sure the Bulb/Reflector Assembly is seated flush in the Bulb Mount Assembly (any error in installation could cause a low output)	Properly install Bulb/Reflector Assembly, see page 17.

Frequently Asked Questions

Q.) My *BlueWave 75* will not turn on.

- Check the power cord connection.
- Check the Fuses located where the Power Cord plugs into the unit.
- If a tone is heard, the Cover Interlock Sensor may not be closed. Verify that the cover is properly closed and that the four side securing screws are tightened. Remove the cover and verify nothing is preventing it from fully seating on the unit.

Q.) The blue lens on the front panel does not light.

- This signifies the Bulb has not ignited. Check that the power cord and Bulb connections are secure.

Q.) The Bulb will not ignite, it only “flickers”.

- Replace the Bulb. Excessive power cycling will shorten the life expectancy of the Bulb. This is an arc, not filament Bulb. Once ignited, it must be left on for a minimum of 10 minutes to vaporize elements in the Bulb. If not, the Bulb may be difficult to re-ignite.

Q.) I installed a new Bulb, and it still will not ignite.

- The *BlueWave 75* has a safety shutdown feature at 2,000 hours. If the equipment has reached the safety shutdown point, "CHANGE BULB" and "2000.0" will alternate on the Hour Meter and the Bulb will not light. When this happens, the *BlueWave 75* will no longer supply an ignition voltage until a new Bulb is installed and the Reset Switch is pressed on the back of the equipment. The power must be on for this reset to be performed. The Reset Switch should always be pressed whenever a new Bulb is installed and a Bulb should never be operated after it reaches the 2,000 hour life expectancy.
- Check and make sure the Bulb Connector is fully seated into the Igniter.

Q.) Why do I have low intensity, even with a new Bulb?

- Standard *BlueWave 75* units have an Optical Filter installed, which filters the energy before it reaches the Lightguide. The intensity may be decreased if the light that passes through the Filter is restricted by dust and debris accumulated on the Filter surfaces.
- The intensity is being checked too early. The 75W Bulb will not reach full intensity until at least five minutes after initial power up.
- The Lightguide may not be fully seated into the Lightguide Mount.
- The end of the Lightguide may have a build-up of adhesive or outgassing residue. Carefully remove with isopropyl alcohol or a razor blade for heavier deposits.
- The condition of the Lightguide will also affect the intensity. All Lightguides degrade with time, but intensity will also drop if the Lightguide is bent or kinked. The intensity reading from the Lightguide should be compared to the intensity reading from a Lightguide Simulator to determine the efficiency.

- The Bulb is not installed correctly. Bulb orientation is vital during the installation of the Bulb. Refer to the Bulb installation instructions supplied with all new 75W Bulbs for the proper installation procedure.

Q.) My Footswitch is not operating.

- Check the connection of the Footswitch into the unit. Check that the Lightguide is fully installed and that the “Lightguide Seated” indicating light is on.

Q.) What causes my Shutter to hesitate to open or close?

- Maintaining clean equipment and a clean working environment will help prevent the build up of dust and other debris from collecting on the mechanical parts of the *BlueWave 75*. Debris that settles in the piston well (Adjustment Screw) can hinder the movement of the Shutter Solenoid Piston.
- Shutter alignment to Reflector Mount incorrect.
- The Shutter is a mechanical part which may wear after extended use.
- The alignment of the Shutter to the Bulb Mount Assembly is incorrect.

Q.) Why does my *BlueWave 75* seem to run very hot?

- Replace the Fan Filter Media on the Exhaust Fan and vent located in the back of the equipment. This is your first line of defense against airborne dust and debris. This Fan Filter Media is supplied with new Bulbs and should be changed regularly.
- Ideal operation of this equipment suggests at least 12" of clearance behind the unit for proper ventilation. Confirm that the Intake Fan is not feeding from the exhaust of other equipment.
- Confirm that the cooling fan is operating.
- The unit may already be full of dust and debris and over heating the internal electronics.

Spare Parts and Accessories

Spare/Replacement Parts

Item	Part Number
Fan Spare Parts	
Fan Filter and Holder	38587
Fan Filter Media	38659
Fan 24 VDC	40204
Fuses	
Fuse: 2.0 Amp, 5 mm x 20 mm	41279
Misc	
Bulb/Reflector Assembly	40205
Clip, Reflector Upper (Teflon)	38548
Clip, Spring, Lower	39609
Feet (Rubber Bumper)	38572
Filter, Dual Fuse IEC AC Inlet	37178
Filter, Bandpass	35986
Footswitch	40402
Harness to Hour Meter	40728
Hour Meter	40730
Power Supply, 75W Assembly	40089
Shutter Guide	40224
Spring, Solenoid Plunger	40309
Shutter, Tear-Drop, SS	40313
Lightguide and Lamp Mount Assembly	40054
Switch, Manual Timer	36654
Switch, Power	36288
Timer, Digital	36287
PCB Temp Sensor	40099
Shield, Temp. Sensor	40419

Options/Accessories

Item	Part Number
Cases	
BlueWave Case with Foam	38679
Lightguides & Accessories	
Liquid-D Lightguide, 5 mm X 1 Meter	5720
Liquid-D Lightguide, 5 mm X 1.5 Meter	5721
Liquid-D Lightguide, 8 mm X 1 Meter	5722
Liquid-D 2-Pole Lightguide, 3 mm X 1 Meter	38476
Liquid-D 3-Pole Lightguide, 3 mm X 1 Meter	38477
Liquid-D 4-Pole Lightguide, 3 mm X 1 Meter	38478
Fiber Optic 2-Pole Lightguide, 3 mm x 1 Meter	39783
Fiber Optic 3-Pole Lightguide, 3 mm x 1 Meter	39787
Fiber Optic 4-Pole Lightguide, 3 mm x 1 Meter	39791
Lightguide Simulator	38408
Lightguide Mounting Stand	39700
Additional liquid and fiber optic single- and multi-pole lightguide configurations are available. Contact Dymax for assistance.	Contact Dymax
Radiometers	
Dymax ACCU-CAL™ 50 Radiometer (Spot Model)	39560

Figure 21. Bulb Assembly Part Numbers

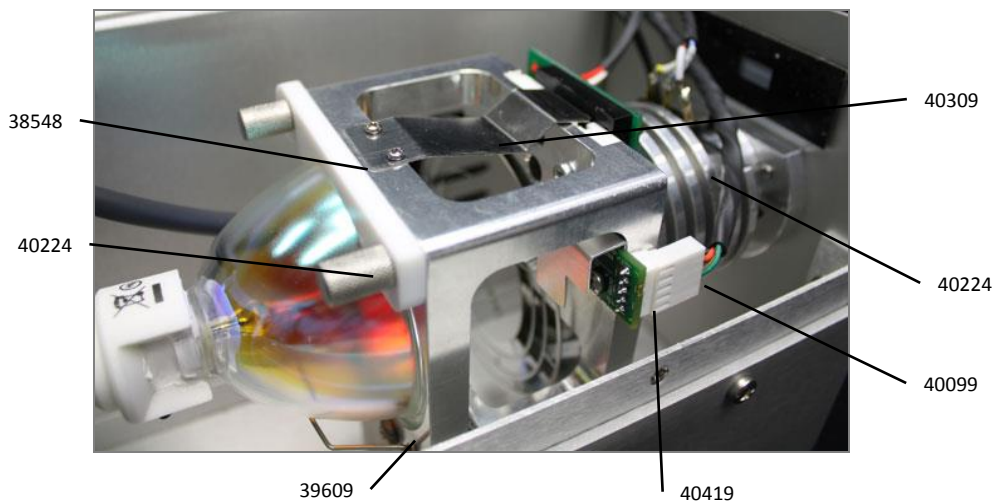

Specifications



Specifications

Property	Specification
Part Number	PN 40078 North American Version (with 115V standard plug) PN 40077 Asian Version (Type G plug) PN 40183 Unit with no power cord*
Intensities**	Total (280-450 nm) 19+ W/cm ²
	Visible (400-450 nm) 9+ W/cm ²
	UVA** (320-395 nm) 9+ W/cm ²
	UVB (280-320 nm) 1.5+ W/cm ²
Power Requirements	100-240 VAC, 50/60 Hz, 1.0 Amps
Power Supply	Solid State, 75 Watt
Bulb	75 Watt arc bulb (included)
Reflector	Elliptical; glass with dichroic coating to reflect UV and minimize IR
Shutter Timer	Digital LED timer up to 99.99 seconds; manual or timed shutter
Shutter Activation	Footswitch
Cooling	Filtered, thermally-controlled single fan configuration
Operating Conditions	Temperature range 2-38°C, humidity limit – non-condensing
Hour Meter	Digital LCD; Total unit operating hours (non re-settable) Total Bulb hours (re-settable)
Housing Dimensions	12" x 12.25" x 6.5" (30.5 cm x 31.1cm x 16.5 cm)
Weight	14 lbs. (6.0 kg)
System Warranty	1 year from date of purchase
Bulb Warranty	2,000 hours (no intensity warranty, only bulb ignition)
Replacement Bulb	PN 40205

* Contains the appropriate power cord for Europe

** Measured with an ACCU-CAL™ 50 radiometer using a lightguide simulator and standard internal "Cool Blue" filter.

Definition of Terms

Bulb - Light source generating ultraviolet, visible, and infrared radiant energy from burning matter stimulated by electrical power conditioned by a proper power supply which is an integral part of a Lamp. A light source is usually placed into a Reflector (of various geometry) to increase light source efficiency by collecting and directing radiant energy of selected spectra (for a given curing process).

Intensity - a measure of energy over the unit of surface area (measured in W/cm^2 or mW/cm^2). This measure is also referred to as “irradiance”.

Brightness, also known as Luminance - description of energy in the visible region of the spectrum (approximately from 400 to 700 nm) and recorded in photometric units. “Intensity” (see below) of visible light energy is called Luminance.

Luminance - luminous flux (energy of visible light) incident per unit area, and measured in Lx (lux) or Lumen/cm².

Ultraviolet (UV) - The invisible region of the spectrum just beyond the violet end of the visible region. Wavelength ranges in general from 1.0 to 400 nm. Dymax bulbs (burners) do not radiate energy in deep ultraviolet; there are very minute amounts below 220 nm and practically nothing can be sensed below 200 nm. This is due to the use of an ozone-blocking quartz-bulb envelope (See Ozone).

- **Ultraviolet A (UV-A)** - UV of long wavelength from within approximately 400 to 320 nm of the spectral band (4000 to 3200).
- **Ultraviolet B (UV-B)** - UV of medium wavelength from within approximately 320 to 280 nm.
- **Ultraviolet C (UV-C)** - UV of short wavelength below 280 nm (we say from 280 to 200 nm) – a large amount of this energy is present in the sunlight.
- **Visible** - Light that can be seen 400-700 nm.

Dose - is irradiance integrated over time, or Irradiance (W/cm^2) x Time (s) = Dose (Joules/cm²). Note: Watt is the power that gives rise to the production of energy at the rate of 1-joule (J) per second (s).

Ozone - oxidizing agent (O₃) produced by the action of Ultraviolet radiant energy (below 185 nm) or electrical corona discharge of oxygen on air.

OSHA 1910.145: “Regulation of Accident prevention Signs and Tags” defines the following headers as:

- **Warning** – is used when there is a hazardous situation that has some probability of severe injury.
- **Caution** - is used to indicate a hazardous situation that may result in minor or moderate injury.
- **Notice** - is used to convey a message related directly or indirectly to the safety of personnel, or protection of property.

OSHA 1910.145: “Regulation de la prevention d’accident Signes et Étiquettes” défin les têtes comme:

- **Avertissement** - est utiliser quand il ya un situation hasardeux qu’il avais de probabilité de se blesser sévère.
- **Pre-Caution** - est user pour indiquer un situation hasardeux qu’il peut être en consequence en minueur ou modère blessure.
- **Attention** - est user pour communiquer un message lié directement ou indirectement à la sécurité de personnel, ou protection de proprieté.

Warranty

From date of purchase, Dymax Corporation offers a one-year warranty against defects in material and workmanship on all system components with proof of purchase and purchase date. Unauthorized repair, modification, or improper use of equipment may void your warranty benefits. The use of aftermarket replacement parts not supplied or approved by Dymax Corporation, will void any effective warranties and may result in damage to the equipment.

Replacement Bulb Warranty

If the bulb fails to ignite during the warranty period of 2,000 hours and all Bulb History Cards for a specific BlueWave® have been returned to Dymax, the bulb will be replaced under warranty.

IMPORTANT NOTE: DYMAX CORPORATION RESERVES THE RIGHT TO INVALIDATE ANY WARRANTIES, EXPRESSED OR IMPLIED, DUE TO ANY REPAIRS PERFORMED OR ATTEMPTED ON DYMAX EQUIPMENT WITHOUT WRITTEN AUTHORIZATION FROM DYMAX. THOSE CORRECTIVE ACTIONS LISTED ABOVE ARE LIMITED TO THIS AUTHORIZATION.

Index

- Assembly and Setup, 9
- Bulb Replacement, 16
- Definition of Terms, 25
- Digit Increment, 13
- Frequently Asked Questions, 20
- Glossary, 25
- Help, 4
- Installation, 10
- Interconnect, 10
- Key Protect, 13
- Lamp Dual Hour Meter, 14
- Maintenance, 15
 - Fan Filter Maintenance, 16
 - Fuse Replacement, 15
 - Lightguide Maintenance, 16
- Mode, 13
- Operation*, 14
- Optional Equipment, 23
- Output Indicator, 13
- Parts Included, 9
- Product Overview, 8
- Reset Button, 13
- Reset Indicator, 13
- Safety, 4
- Sécurité, 5
- Set Value, 13
- Settings and Adjustments, 11
 - Intensity Adjustment, 11
 - Intensity Control, 12
 - Intensity Validation, 12
 - Lamp Dual Hour Meter, 14
 - Setting the Cycle Duration, 12
- Shutter Timer, 12
- Sicherheitshinweise, 5
- Spare Parts and Accessories, 22
- Specifications, 24
- Support, 4
- Terms, 25
- Timing Value, 13
- Troubleshooting, 19
- Unpacking, 9
- UV Light-Curing System Safety Considerations, 6
 - Bright, Visible Light, 7
 - High-Temperature Surfaces, 7
 - Ozone, 7
 - UV Exposure, 6
- Warranty
 - Replacement Bulb Warranty, 26
- Warranty
 - General Warranty, 26



© 2012-2014 Dymax Corporation. All rights reserved. All trademarks in this guide, except where noted, are the property of, or used under license by Dymax Corporation, U.S.A.

The data contained in this bulletin is of a general nature and is based on laboratory test conditions. Dymax Europe GmbH does not warrant the data contained in this bulletin. Any warranty applicable to products, its application and use is strictly limited to that contained in Dymax Europe GmbH's General Terms and Conditions of Sale published on our homepage http://www.dymax.com/de/pdf/dymax_europe_general_terms_and_conditions_of_sale.pdf. Dymax Europe GmbH does not assume any responsibility for test or performance results obtained by users. It is the user's responsibility to determine the suitability for the product application and purposes and the suitability for use in the user's intended manufacturing apparatus and methods. The user should adopt such precautions and use guidelines as may be reasonably advisable or necessary for the protection of property and persons. Nothing in this bulletin shall act as a representation that the product use or application will not infringe a patent owned by someone other than Dymax Corporation or act as a grant of license under any Dymax Corporation Patent. Dymax Europe GmbH recommends that each user adequately test its proposed use and application of the products before actual repetitive use, using the data contained in this bulletin as a general guide. PN40153 MAN016EU 2/26/2014

Dymax Corporation
860.482.1010 | info@dymax.com | www.dymax.com

Dymax Europe GmbH
+49 (0) 611.962.7900 | info_de@dymax.com | www.dymax.de

Dymax Engineering Adhesives Ireland Ltd.
+353.1.231.4696 | info_ie@dymax.com | www.dymax.com

Dymax Oligomers & Coatings
860.626.7006 | info_oc@dymax.com | www.dymax-oc.com

Dymax UV Adhesives & Equipment (Shanghai) Co. Ltd.
+86.21.37285759 | dymaxasia@dymax.com | www.dymax.com.cn

Dymax UV Adhesives & Equipment (Shenzhen) Co. Ltd.
+86.755.83485759 | dymaxasia@dymax.com | www.dymax.com.cn

Dymax Asia (H.K.) Limited
+852.2460.7038 | dymaxasia@dymax.com | www.dymax.com.cn

Dymax Asia Pacific Pte. Ltd.
+65.6752.2887 | info_ap@dymax.com | www.dymax-ap.com

Dymax Korea LLC
+82.2.784.3434 | info_kr@dymax.com | www.dymax.com/kr